

# Photovoltaic Generator with Battery Storage

Professor A. P. Kinge<sup>1</sup>, Shweta Dikshit<sup>2</sup>

<sup>1</sup>Department of Electrical Engineering, TSSM'S Bhivarabai Sawant College of Engineering and Research Narhe, Pune

<sup>2</sup>M.E.Electrical(Power System)Department of Electrical Engineering, TSSM'S Bhivarabai Sawant College of Engineering and Research, Narhe Pune

\*\*\*

**Abstract** - Renewable resources such as Solar Photovoltaics generator plays a vital role with battery for supplying power to loads. The system comprises of a battery, PV panel and a buck converter circuit, inverter and load. Here Battery plays two roles, one it acts as a load for PV Panel and other it acts as an energy storage device. The buck converter tracks the maximum power from the PV panel by changing the duty cycle. Perturbation and observation method is used as MPPT (Maximum Power Point Tracking) control algorithm to extract maximum power from the PV panel. Inverter PWM technique is used for controlling the output voltage across AC loads.

**Key Words:** MPPT Maximum power point Tracking, PV Photovoltaics, PWM Pulse Width Modulation, AC Alternating Current

## 1. INTRODUCTION

Using a solar panel or an array of panels without a controller that can perform Maximum Power Point Tracking (MPPT) will often result in wasted power, which ultimately results in the need to install more panels for the same power requirement. For smaller devices that have the battery connected directly to the panel, this will also result in premature battery failure or capacity loss, due to the lack of a proper end-of-charge procedure and higher voltage. If MPPT controller is not used it will result in a higher installation cost and, in time, the costs will escalate due to eventual equipment failure. Even with a proper charge controller, the prospect of having to pay 30-50% more up front for additional solar panels makes the MPPT controller very attractive. MPPT controller can be implemented by operating directly on the converter duty cycle. In this case, the algorithm modifies the solar panel operating voltage by using a proportional integral (PI) control loop, which steers the voltage to the desired value. Solar PV generators and Battery both plays an important role in controlling output voltage across ac loads with the help of Inverter PWM Technique.

## 2. MAXIMUM POWER POINT TRACKING (MPPT)

Maximum Power Point Tracking (MPPT) is used to improve the efficiency of a particular solar panel. Maximum Power

Point Tracking (MPPT) is an algorithm that is used to extract maximum power from PV under specific conditions. Maximum power of a PV panel depends on factors such as solar irradiation, ambient temperature and cell temperature. Normally a PV module produces maximum power voltage at cell temperature of 25°C. However depending on outside temperature it can fall or rise. MPPT checks the output of a particular PV panel and after comparing it with battery voltage decides the most efficient voltage i.e. maximum power point voltage.

The purpose of a MPPT system is applying proper resistance after sampling output of PV cell in order to obtain maximum power. MPPT is most effective in cooler conditions because PV module works better at cold temperatures. It is also very effective when the battery is deeply discharged because more current can be extracted under low charge conditions. . MPPT devices is an electronic DC to DC converter that optimizes the match between the solar array (PV panels) and the battery bank. By adjusting the nominal duty cycle of the DC-DC converter, the input resistance can be made equal to the equivalent output resistance of the solar PV panel and ensures the maximum power transfer. They convert a higher voltage DC output down to lower voltage needed to charge the batteries. The Maximum Power Tracker uses an iterative approach to finding this constantly changing MPP. This iterative method is called hill climbing algorithm. To achieve MPPT, the controller adjusts the voltage by a small amount from the solar panel and measures power, if the power increases, further adjustments in the direction are tried until power no longer increases. The voltage to the solar panel is increased initially, if the output power increase, the voltage is continually increased until the output power starts decreasing. Once the output power starts decreasing, the voltage to the solar panel decreased until maximum power is reached. This process is continued until the MPPT is attained. This result is an oscillation of the output power around the MPP.

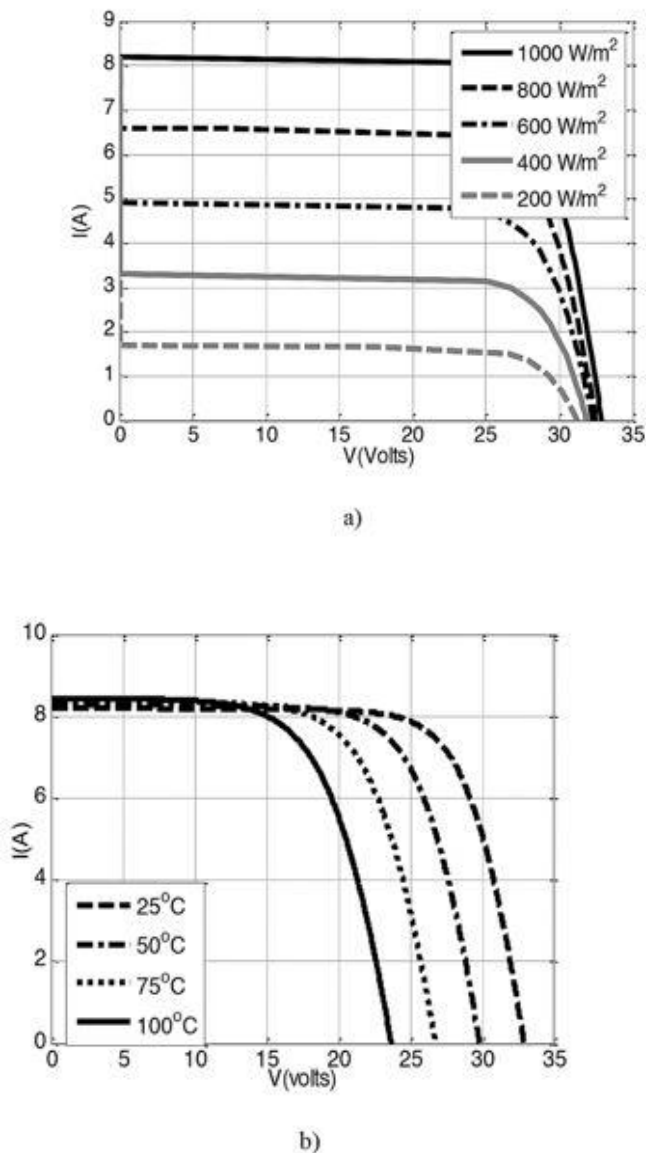
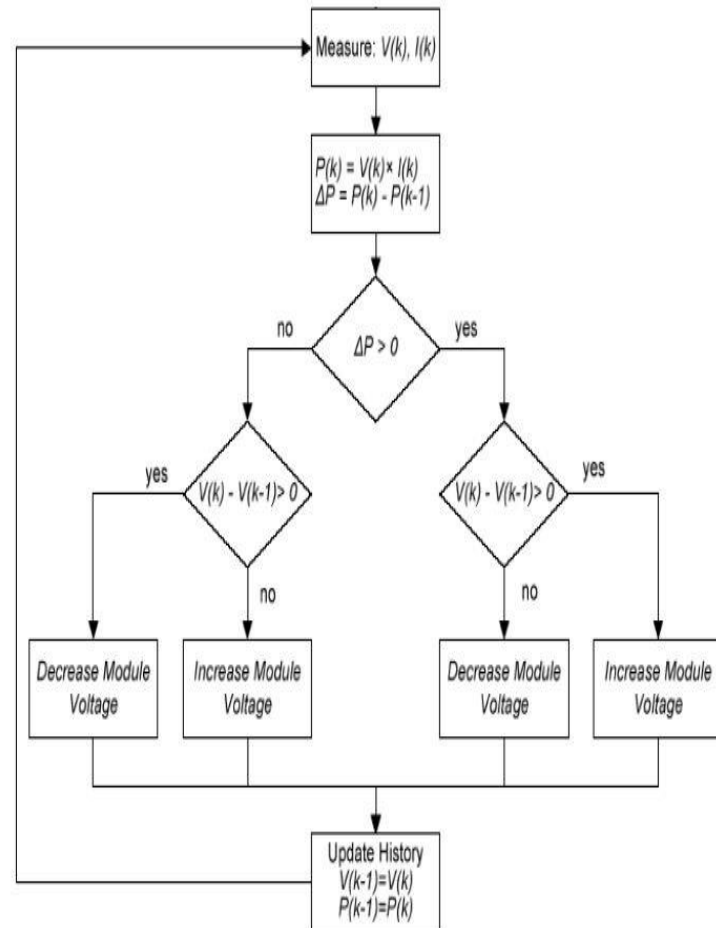

**Fig -1 :** (a) I-V characteristics of PV panel for different irradiance level. (b) I-V characteristics corresponding to different temperature.

### 3. PERTURB AND OBSERVE ALGORITHM

The perturb & observe (P&O) algorithm, also known as the “hill climbing” method, is very popular and commonly used because of its simplicity in algorithm and the ease of implementation. In this algorithm the operating voltage of the PV module is perturbed by a small increment, and the resulting change of power, P, is observed. If the P is positive, then it is supposed that it has moved the operating point closer to the MPP. Thus, further voltage perturbations in the same direction should move the operating point toward the MPP. If the P is negative, the operating point has moved away from the MPP, and the direction of perturbation should be

reversed to move back toward the MPP. Figure 2 shows the flowchart of this algorithm.



**Fig -2:** The flowchart of P and O algorithm for tracking maximum power from PV panel

### 4. BUCK CONVERTER

A buck converter (step-down converter) is a DC –DC converter which steps down voltage (while stepping up current) from its input (supply) to its output (load level). When the switch is ON, current flows through the inductor (L), load (R) and the output capacitor (C) as shown in the figure 3. In this condition the diode is reverse biased. So no current flows through it. During the ON state magnetic energy is stored in the inductor and electrical energy is stored in the output capacitor. When the switch is off, stored Energy in the Inductor is collapsed and current complete its path through the diode (forward biased) as shown in Figure 4. When stored energy in the inductor vanishes, stored energy in the capacitor is supplied to load to maintain the current.

On-State

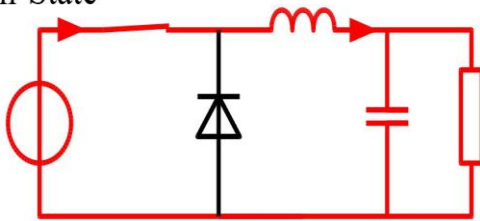

Fig -3: Buck Converter ON State

Off-State

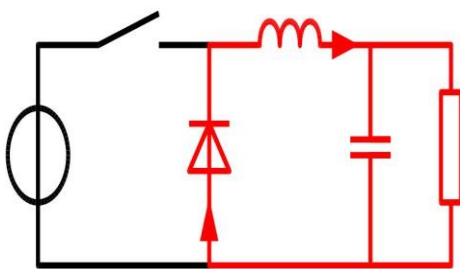

Fig -4: Buck Converter OFF State

### 5. INVERTER PWM TECHNIQUE

Inverters based on PWM technology are superior in many factors compares to other inverters, the PWM based inverter generally use MOSFET in the output switching stage. The simplest way to generate the PWM signal is the interactive method, which requires triangular waveform and a comparator, when the value of the reference signal is more than carrier waveform the PWM signal is in high state otherwise low state. PWM is used in efficient voltage regulators by switching voltage to the load with approximate a voltage of a desired level, when it is lower than the desired voltage it turns on the switch, when the output voltage is above the desired voltage it turns off the switch. The PWM technology corrects the output voltage according to the value of load by changing the width of the switching pulse. The PWM controller in the inverter will make corrections in the pulse width of the switching pulse based on the feedback voltage. This will cancel the changes in the output voltage and inverter will give steady state output voltage irrespective of the load characteristics.

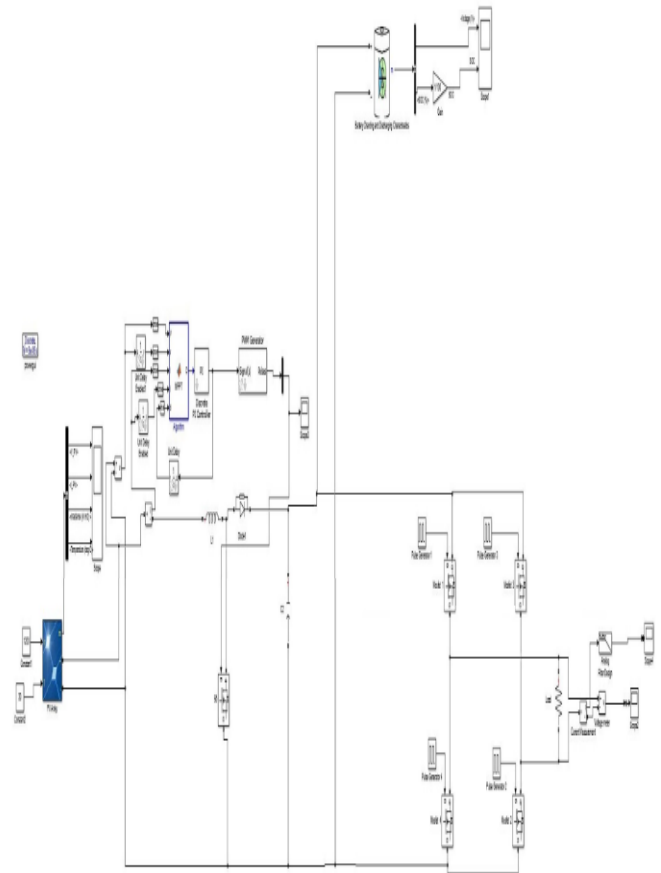

Fig -5: Solar PV Generator with MPPT and Battery with controlled output voltage

### 6. RESULTS

For MPPT technique Duty cycle decreases with increase in operating voltage. Battery is charged through Solar PV generator and is supplying power to ac loads with the help of inverter. Inverter PWM (Pulse Width Modulation) technique is used for controlling the output voltage across ac loads.

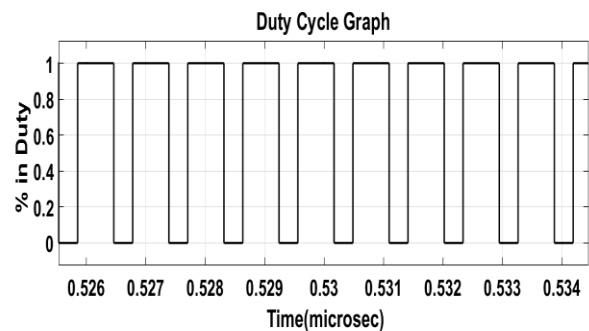

Fig -6: Duty cycle graph at an irradiance of 1200 watt/meter square

At an Irradiance of 1200 watt/meter square of 40 watt solar panel the Duty cycle is 53%

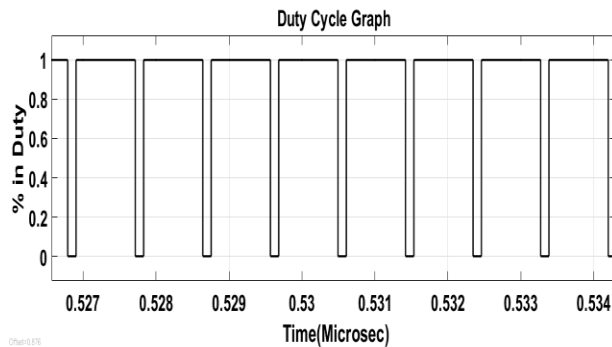

Fig -7: Duty cycle graph at an irradiance of 500 watt/meter square

At an Irradiance of 500 watt/meter square of 40 watt solar panel the Duty cycle is 59.1%.

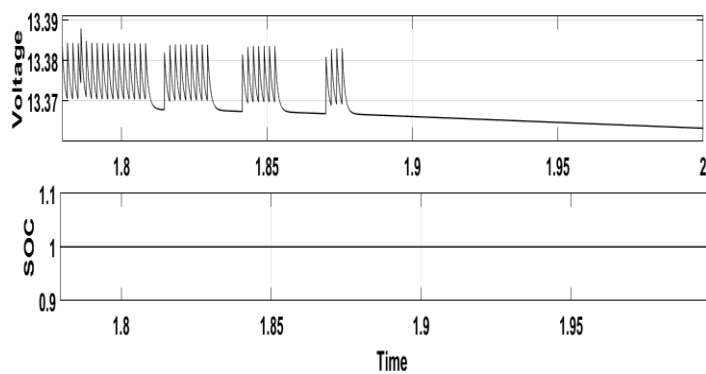

Fig -8: Battery charging/Discharging graph

12 volt battery is used for simulation and it is charged by solar PV generator and then it is discharged as ac load is connected.

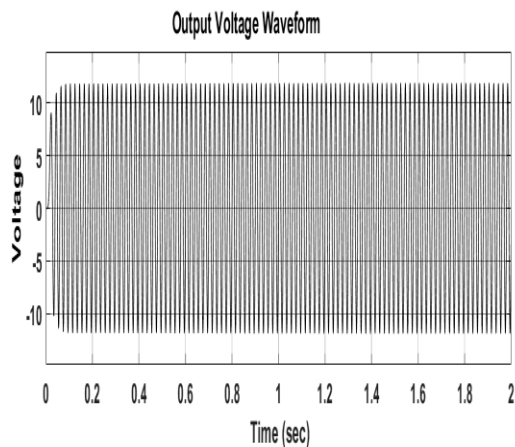

Fig -9: Output Voltage waveform

Inverter PWM (Pulse Width Modulation) Technique is used in controlling the output voltage across ac loads.

## 7. CONCLUSION

A renewable resource such as Photovoltaic System plays a vital role in producing electricity and supplying power to loads. Maximum power point tracking method such as perturb and observe algorithm is implemented so that less numbers of panels required for obtaining same amount of power by changing the duty cycle of converter. Here Battery plays two roles, one it acts as a load for PV Panel and other it acts as an energy storage device, through which inverter is connected to supply power to connected ac loads and maintaining controlled output voltage by inverter PWM technique.

## REFERENCES

- [1] Trishan Eeram, "Comparison of Photovoltaic Array Maximum Power Point Tracking Techniques," IEEE Trans. Energy Convers, VOL. 22, NO. 2, JUNE 2007.
- [2] Sarina Adhikari, "Coordinated V-f and P-Q Control of Solar Photovoltaic Generators With MPPT and Battery Storage in Microgrids," IEEE Trans. Smart Grid., vol. 5, no. 3, May. 2014
- [3] Muralidhar Killi, Susovon Samanta "Modified Perturb and Observe MPPT Algorithm for Drift Avoidance in Photovoltaic Systems", IEEE Transactions on Industrial Electronics, Volume 62, Issue 9, pp.5549 - 5559, Jul. 2015
- [4] W. Xiao and W. G. Dunford, "A modified adaptive hill climbing MPPT method for photovoltaic power systems", in Proc. IEEE PESC, 2004, pp. 1957-1963